

# LOLA 3 LITRES



**Ref: 560481  
(LOLA3)**

**HOT CHOCOLATE DISPENSER LOLA 3 LITERS STD BLACK**

## General Features

LOLA 3 is an excellent, compact unit for heating and dispensing hot chocolate, milk, tea and any other hot beverage or soup.

It is a light, compact unit and suitable for all venues, especially where countertop space is limited.

The eye-catching transparent bowl, 3-litres capacity, attracts impulse purchases.

The bowl can be easily removed, so that unused product can be stored in the fridge overnight to reduce waste.

Lola comes with a vertical tap, this avoids blocking and the unit is extremely easy to clean and to disassemble.

Lola has a mixing system which prevents products from settling at the bottom of the bowl, and that ensures the perfect product consistency; the heating plate assures proper temperature distribution.

LOLA 3 is a compact, plug-and-play, hot chocolate dispenser, ideal for cafeterias, cafes, catering and accommodation facilities, ice-cream shops, dessert bars and other venues, thanks to its small footprint.

# LOLA 3 LITRES

## Specifications

- Perfect equipment for hot chocolate, milk, tea and any other hot beverage or soup.
- Thanks to its compact design, this hot chocolate dispenser is perfect for small spaces.
- It is possible to customize the graphics on the front and on the back (subject to negotiation)
- The eye-catching transparent bowl, 3-litres capacity, attracts impulse purchases.

## Construction

- The bowl is extractable, so that can be easily removed and stored in the fridge overnight, preventing any product wastage.
- The vertical tap, designed to be user-friendly, is easy to disassemble and to clean, and avoids blocking.
- The mixing system prevents products from settling at the bottom of the bowl, and it ensures the perfect product consistency.
- The heating plate assures proper temperature distribution.
- Small footprint.
- The equipment comes with a flavour-label holder

# LOLA 3 LITRES

## Electric

Supply voltage:	220-240 V / 1 ph / 50 Hz
Electrical power max.:	0.85 kW
Current consumption:	3.7 Amps
Plug type:	CE-SCHUKO

## Key Information:

Number of bowls:	1
Bowl's capacity:	3 lt
Dimensions, Width:	233 mm
Dimensions, Depth:	281 mm
Dimensions, Height:	436 mm
Net weight:	5.2 kg
Max selectable temperature:	90° C

## Certifications



The company reserves the right to make modifications to the products without prior notice. All information correct at time of printing.

2024.10.18

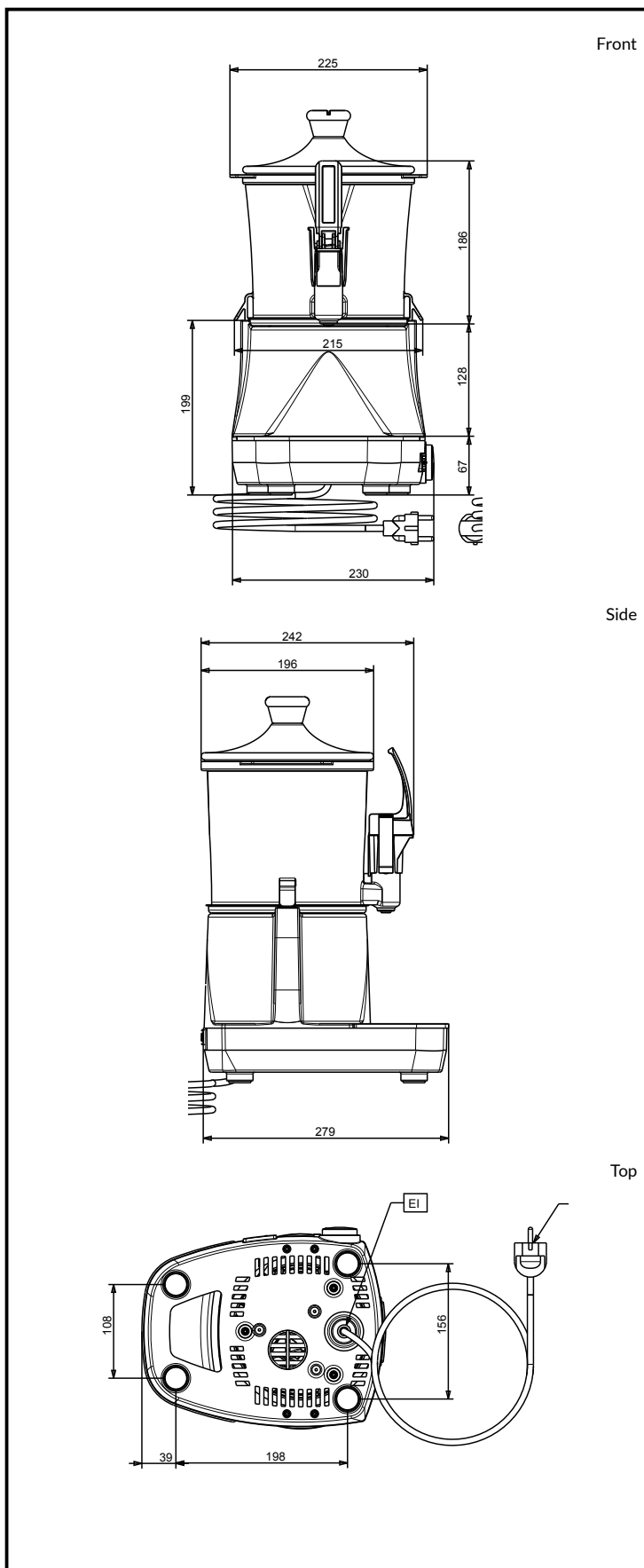

# SPM

www.spm.drink-systems.com  
infospm@electroluxprofessional.com